

1610

---

## Drawing Machine

---

94 pieces

---

A custom model design by  
Jason Allemann

[jkbrickworks.com](http://jkbrickworks.com)

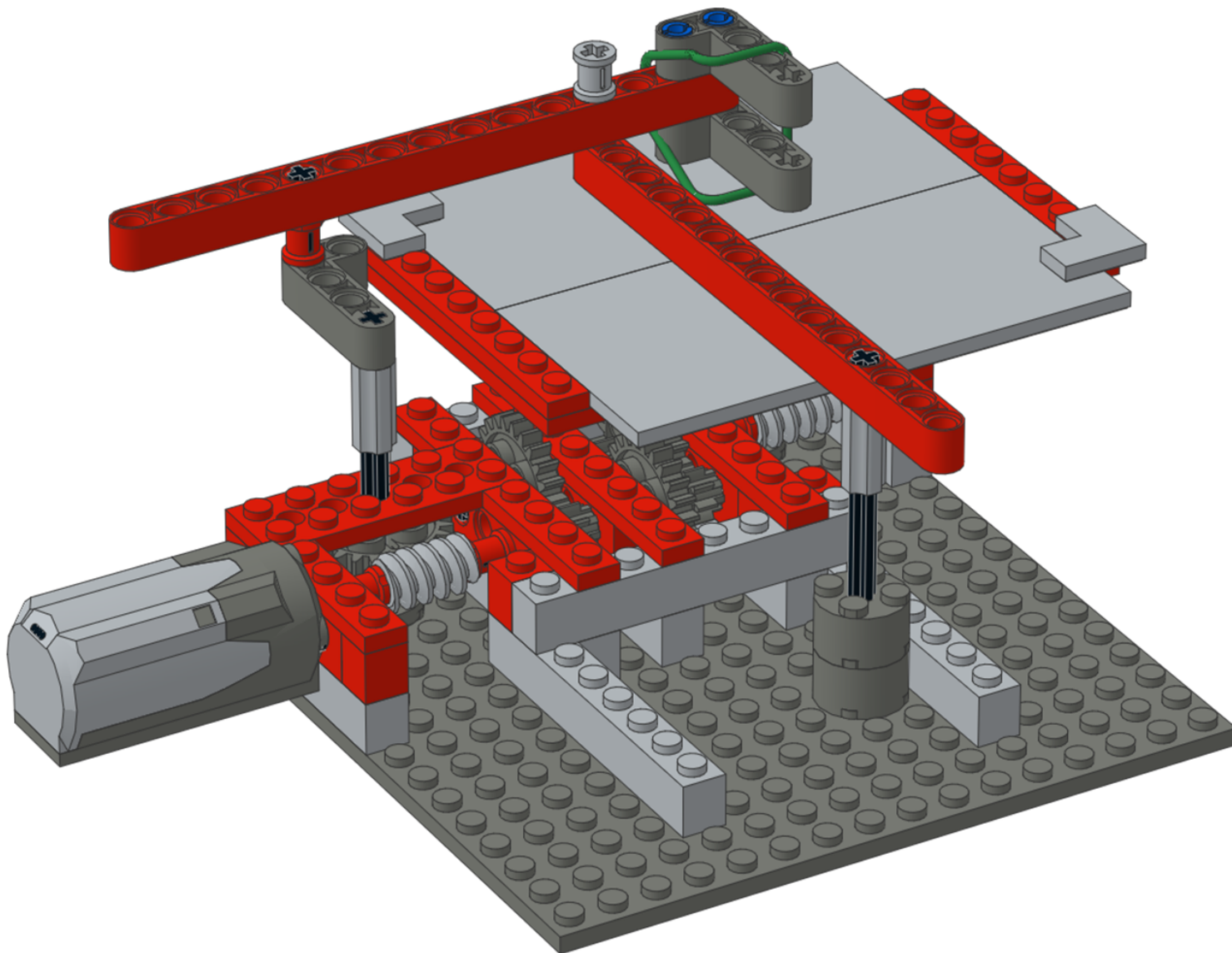

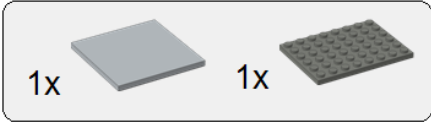
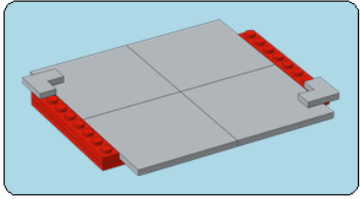

**1**

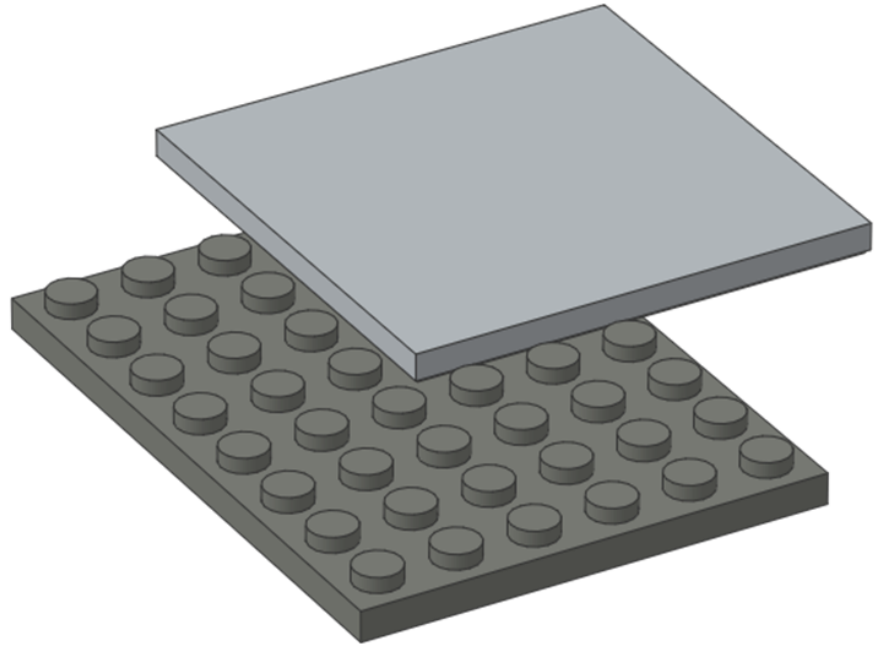

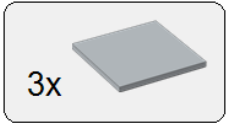

**2**

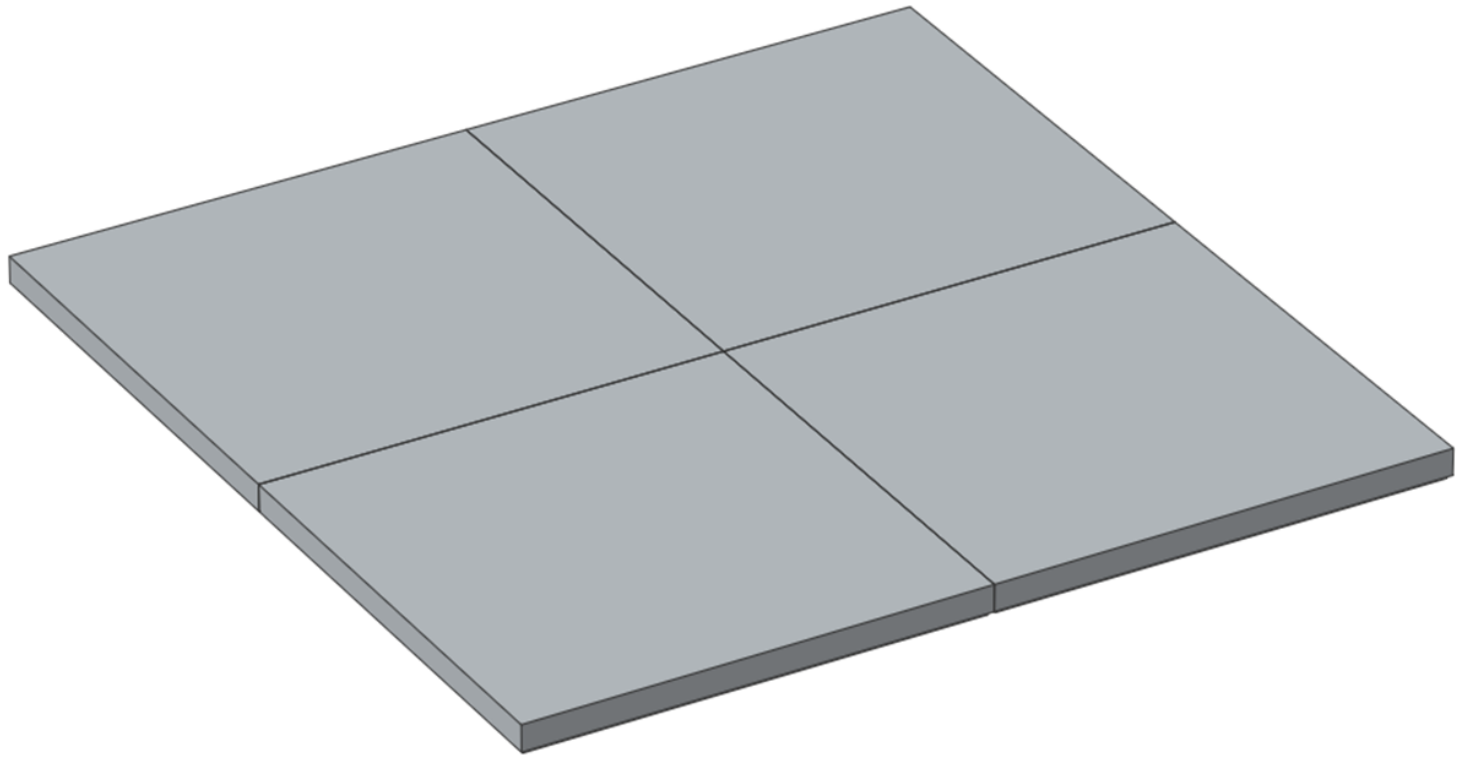

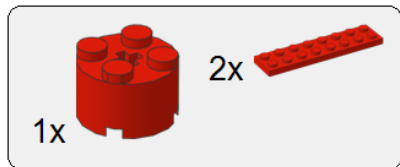

3

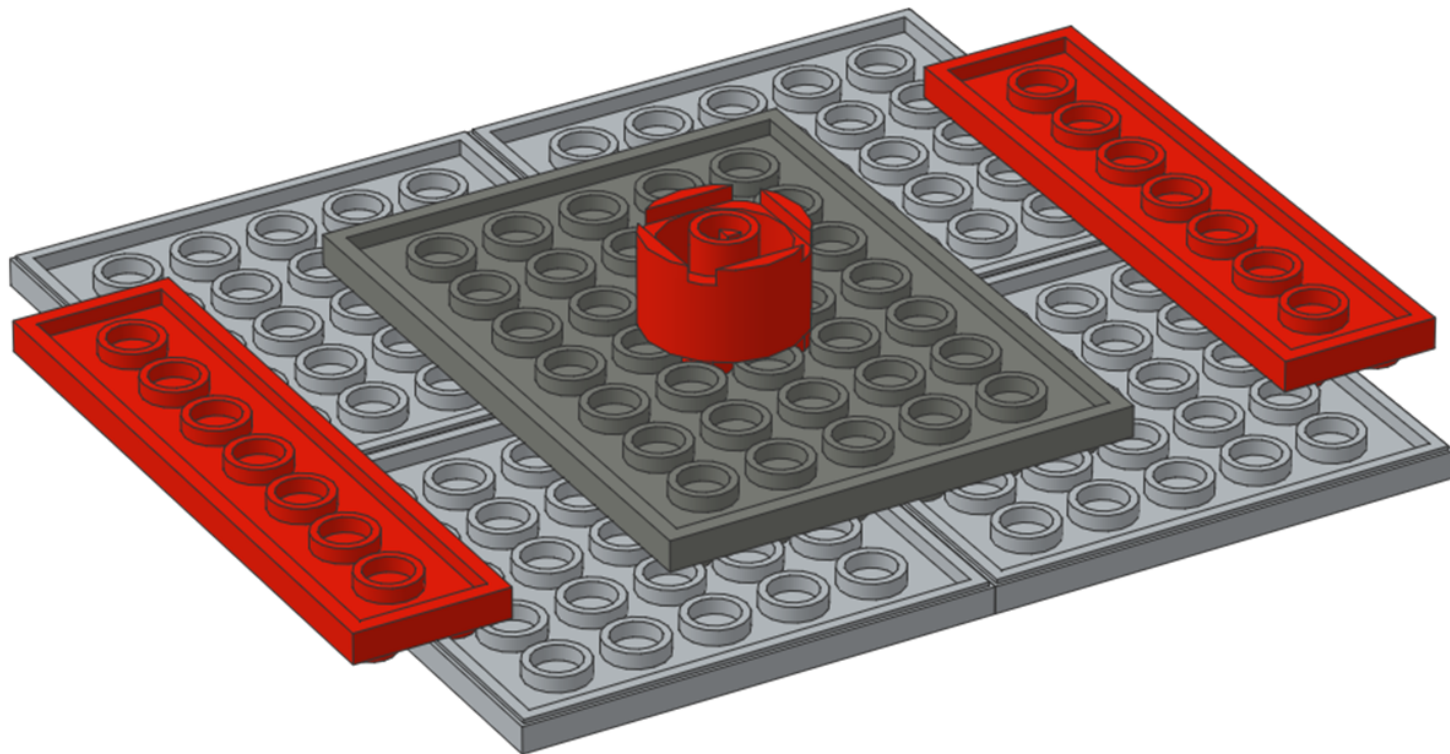



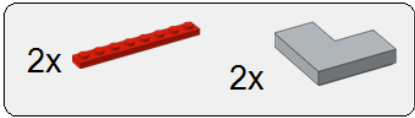

4

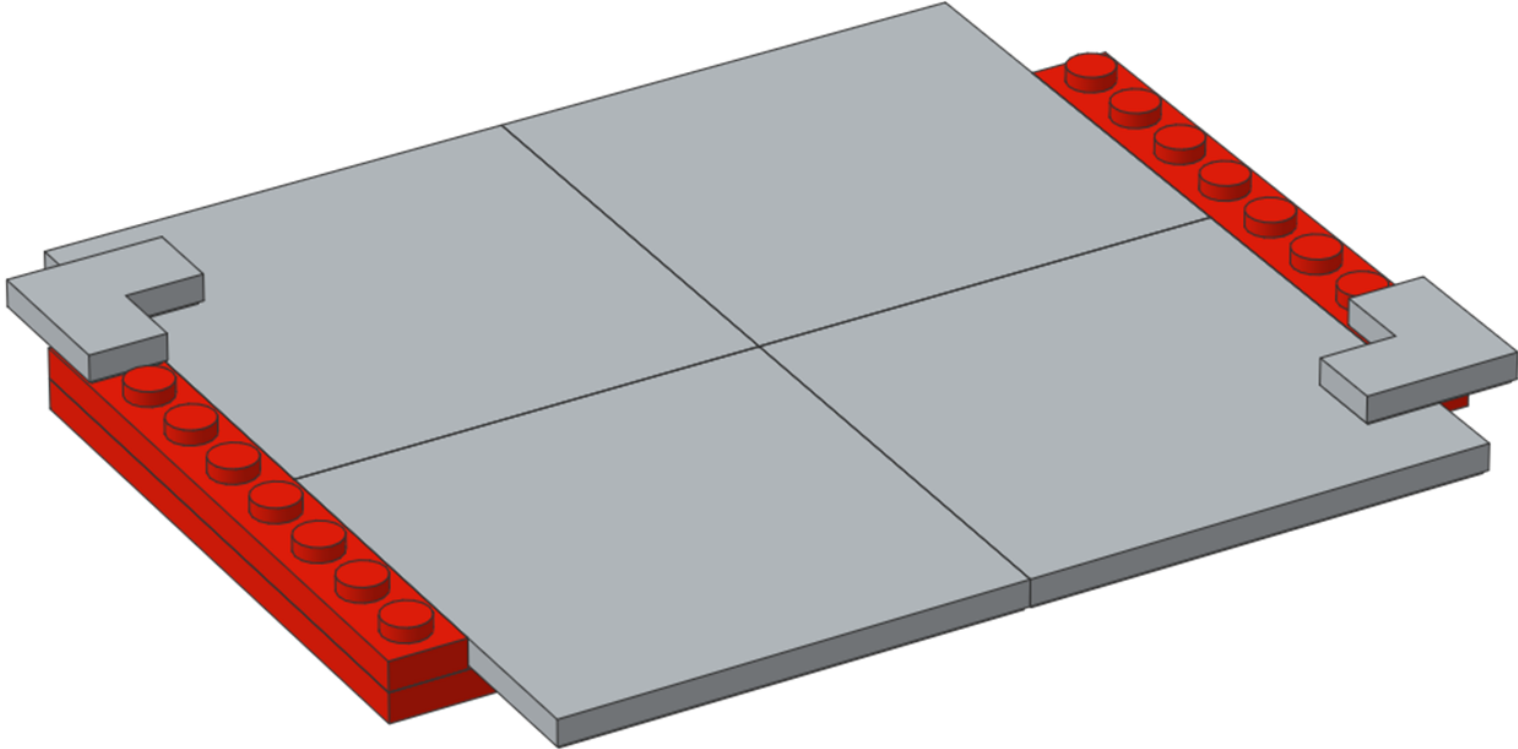

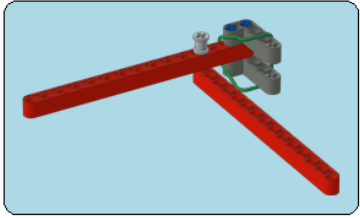

- 2x 
- 1x  15L
- 1x 

**1**

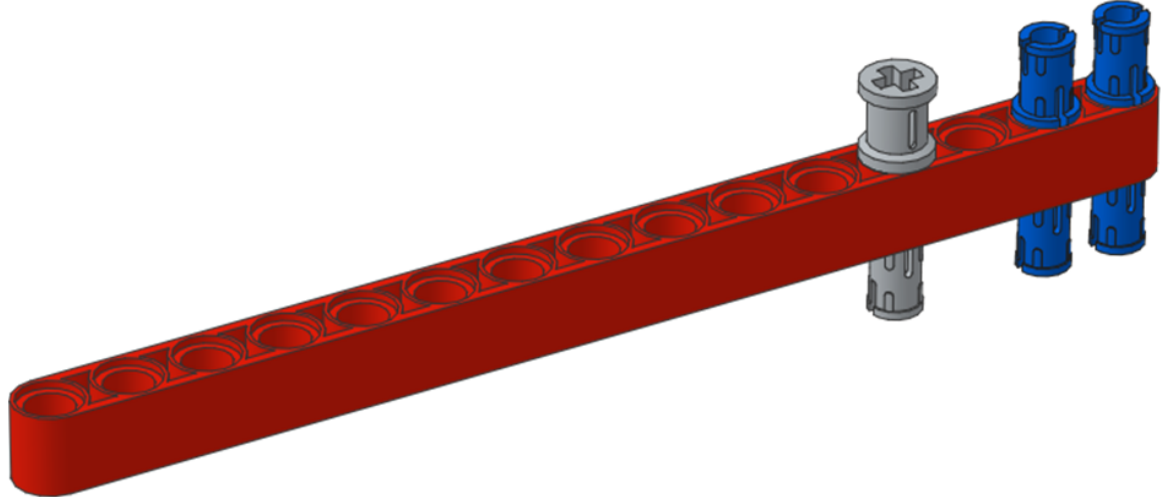

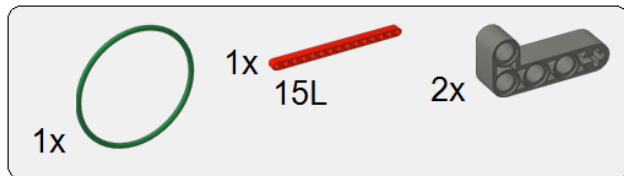

**2**

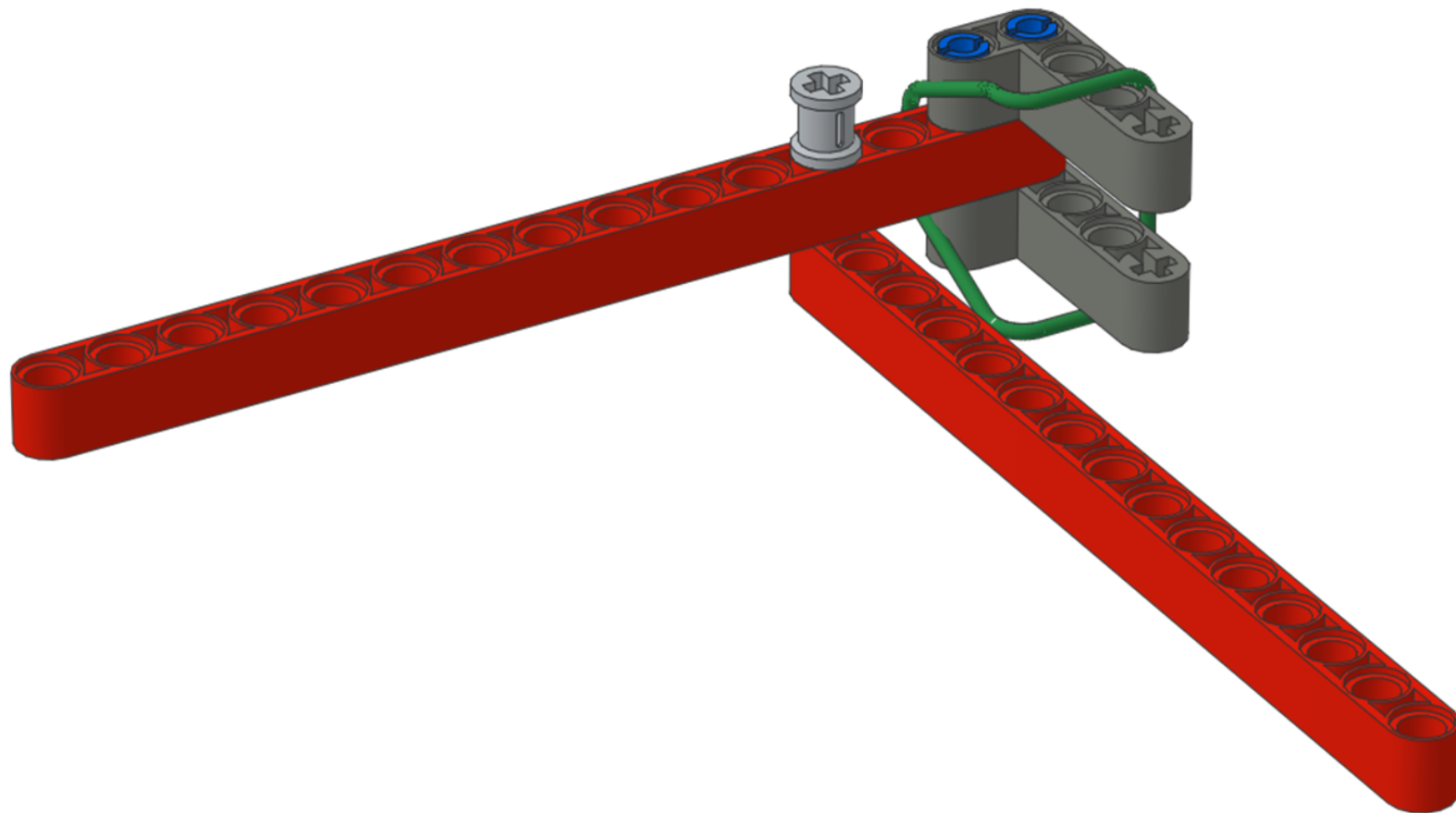

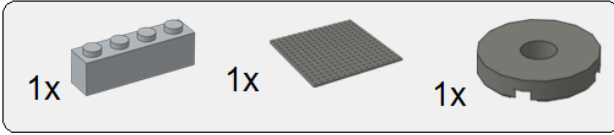
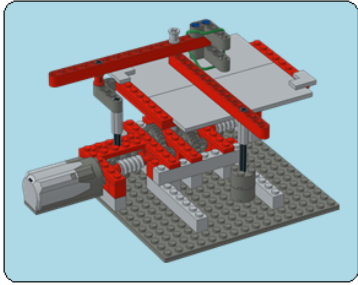

**1**

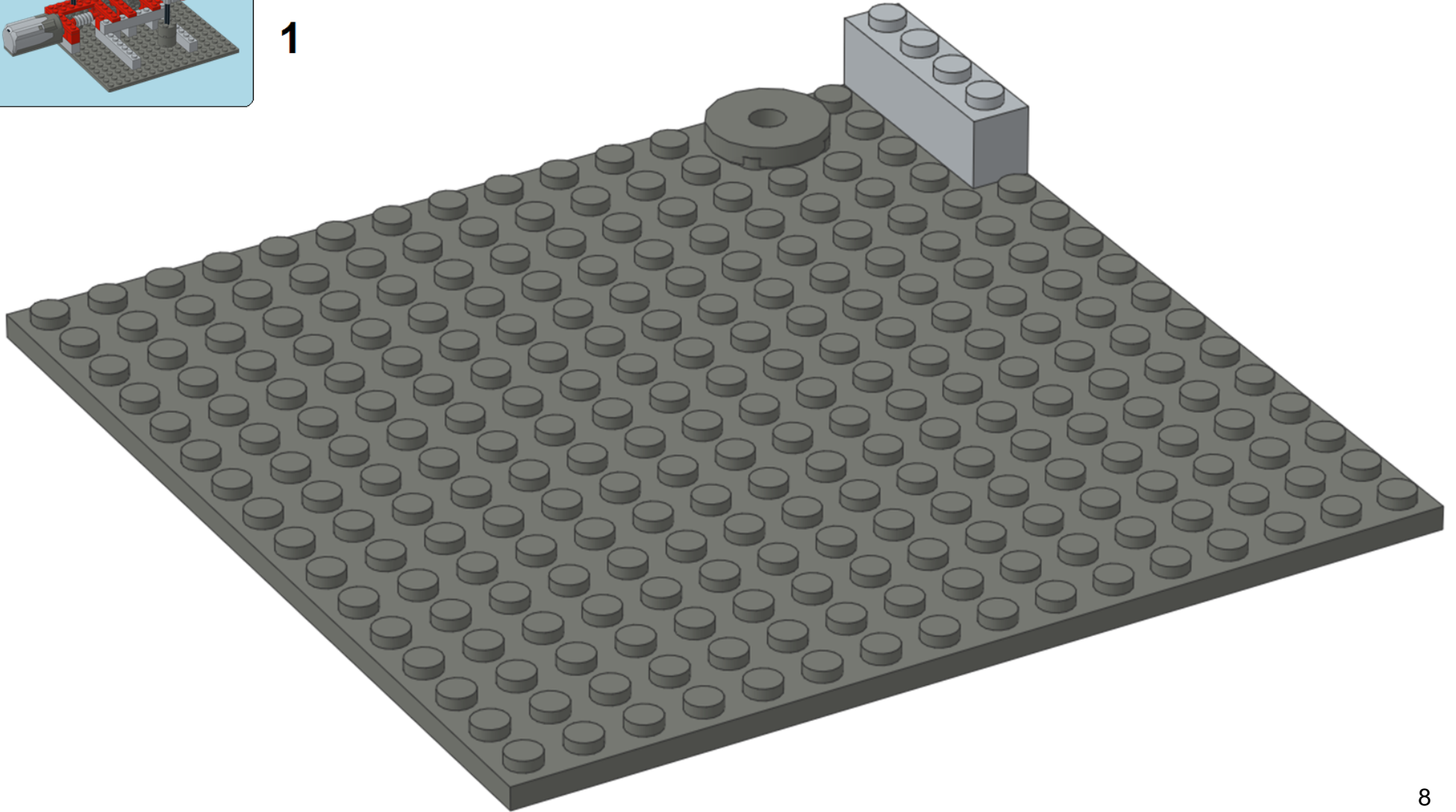

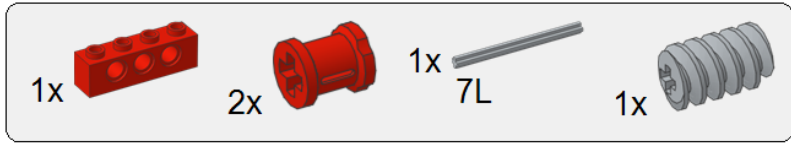

2

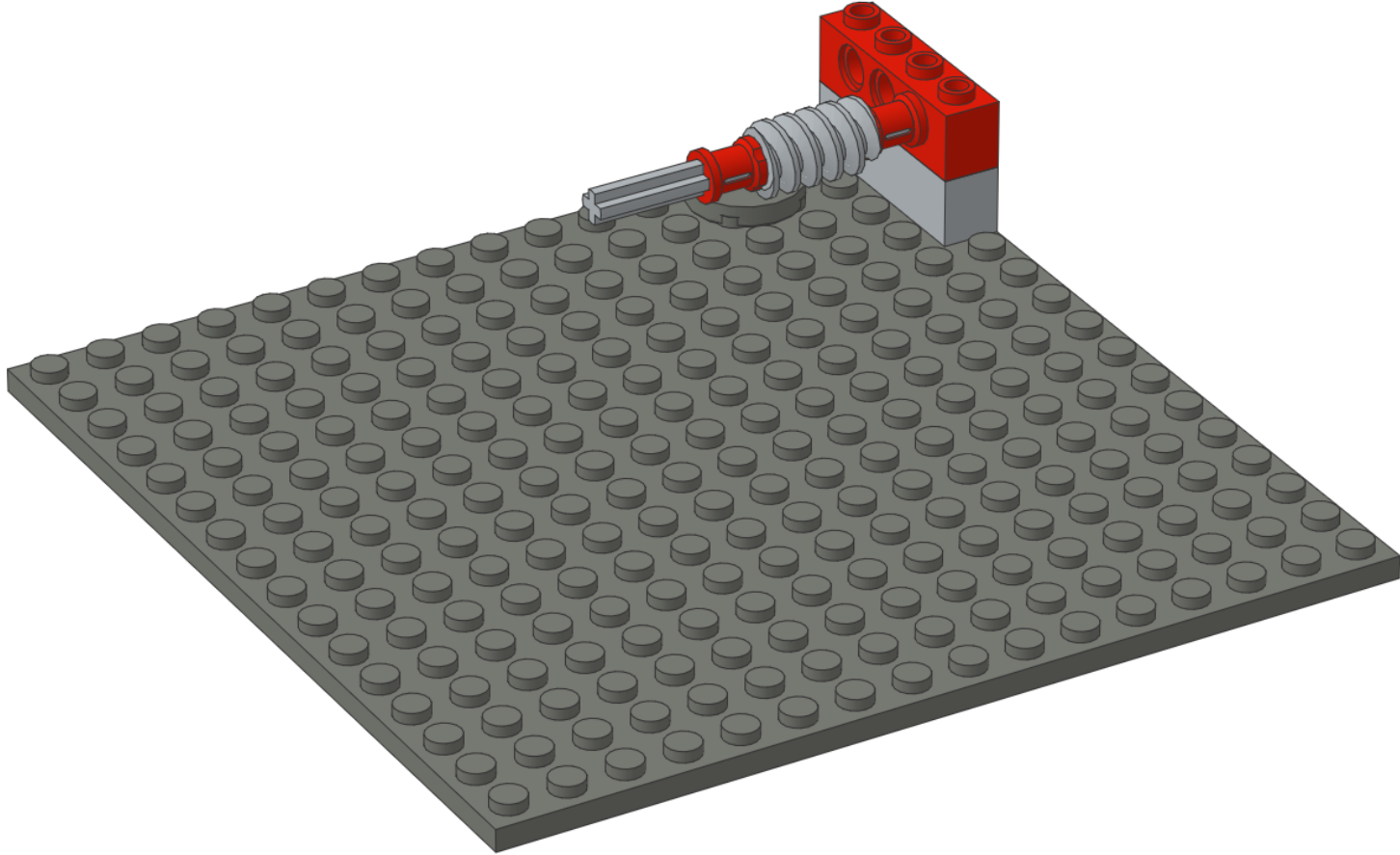

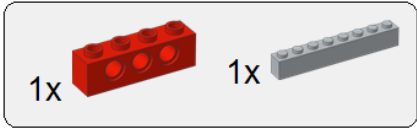

**3**

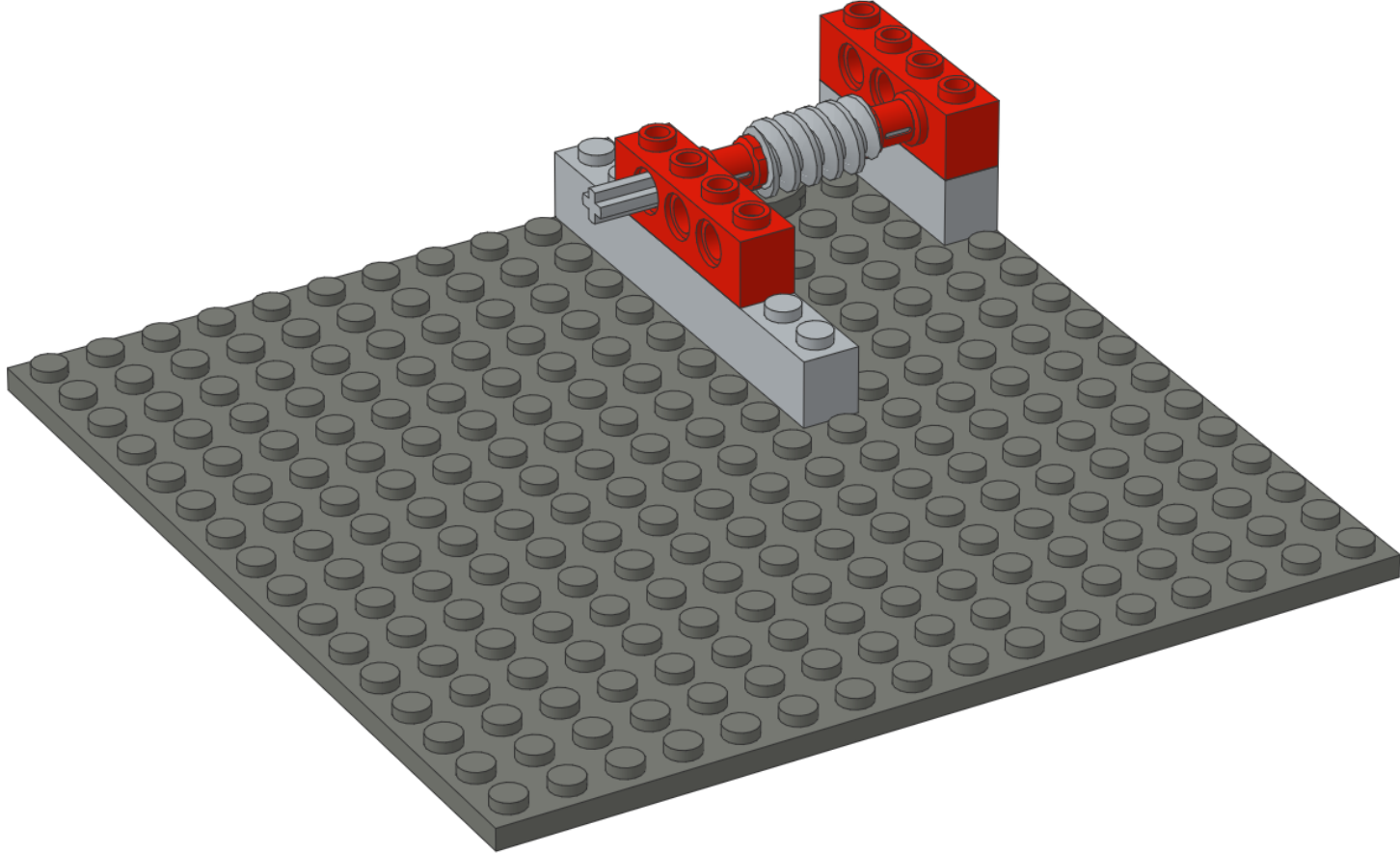

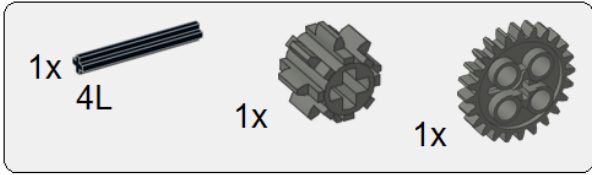

4

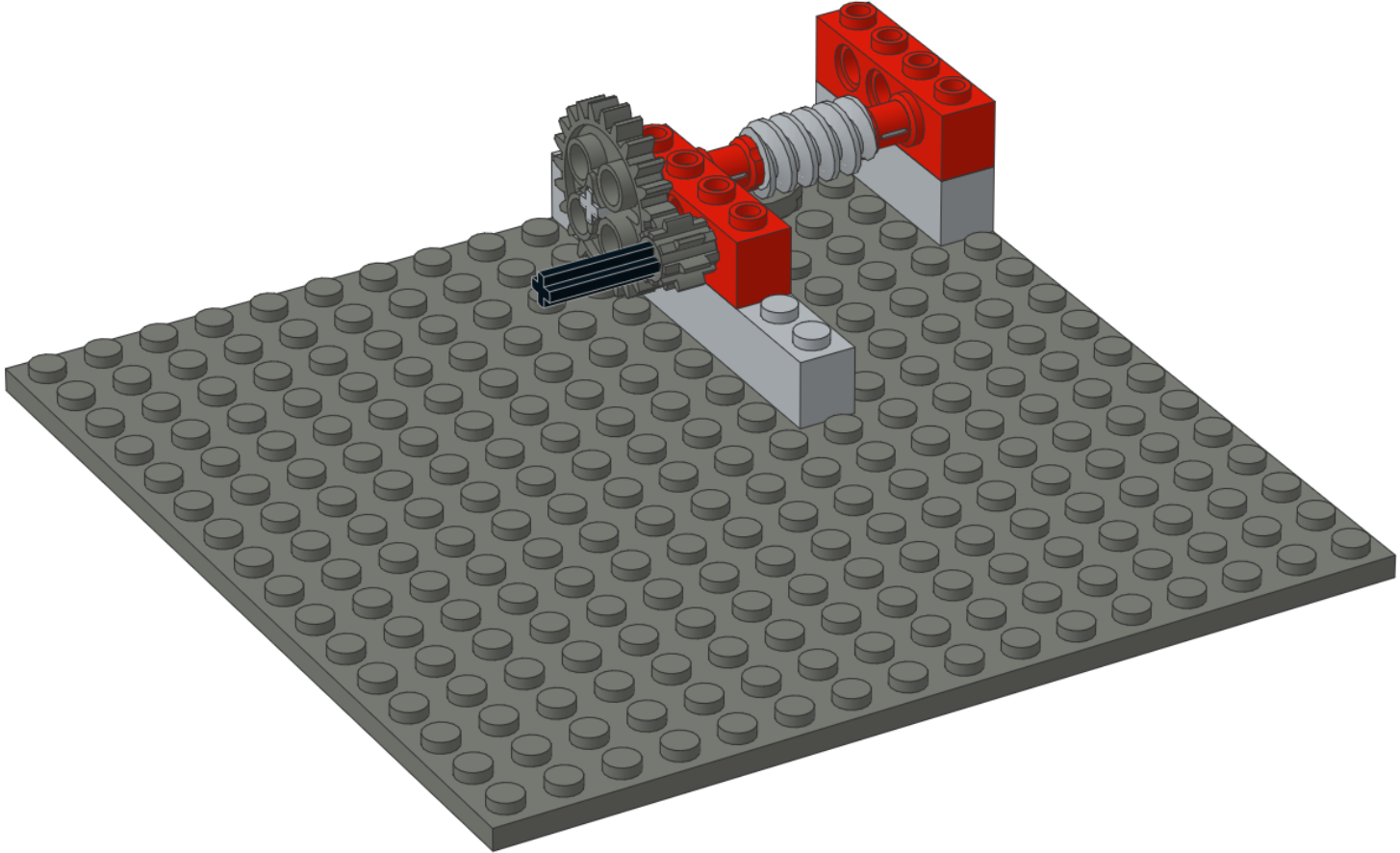



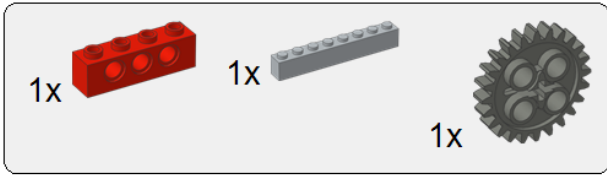

**5**

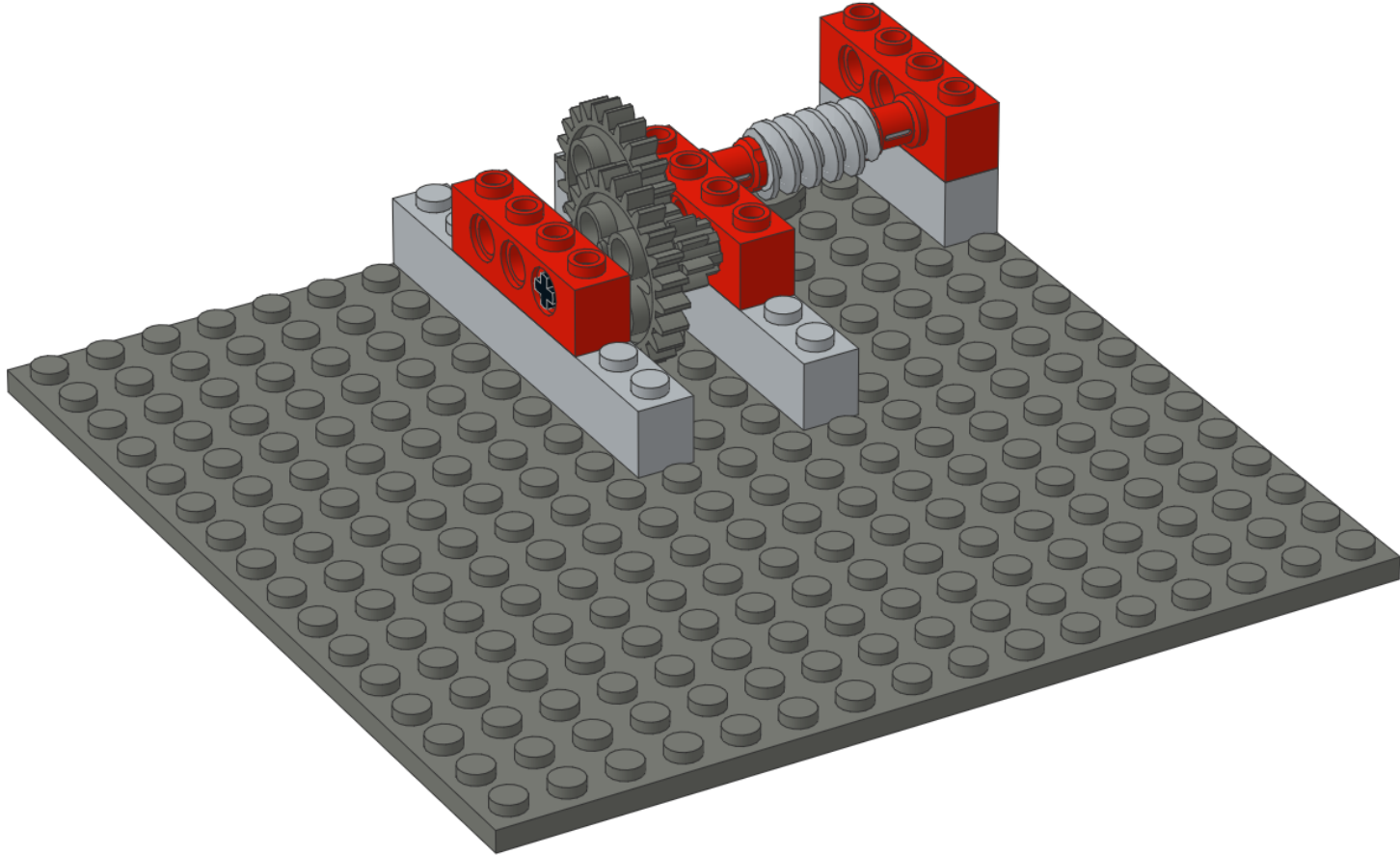



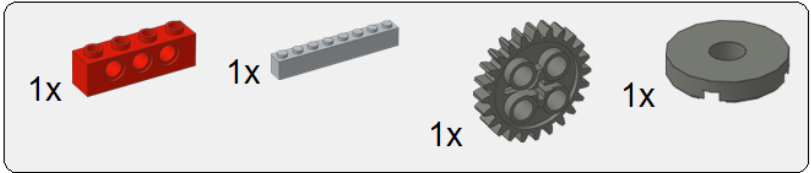

7

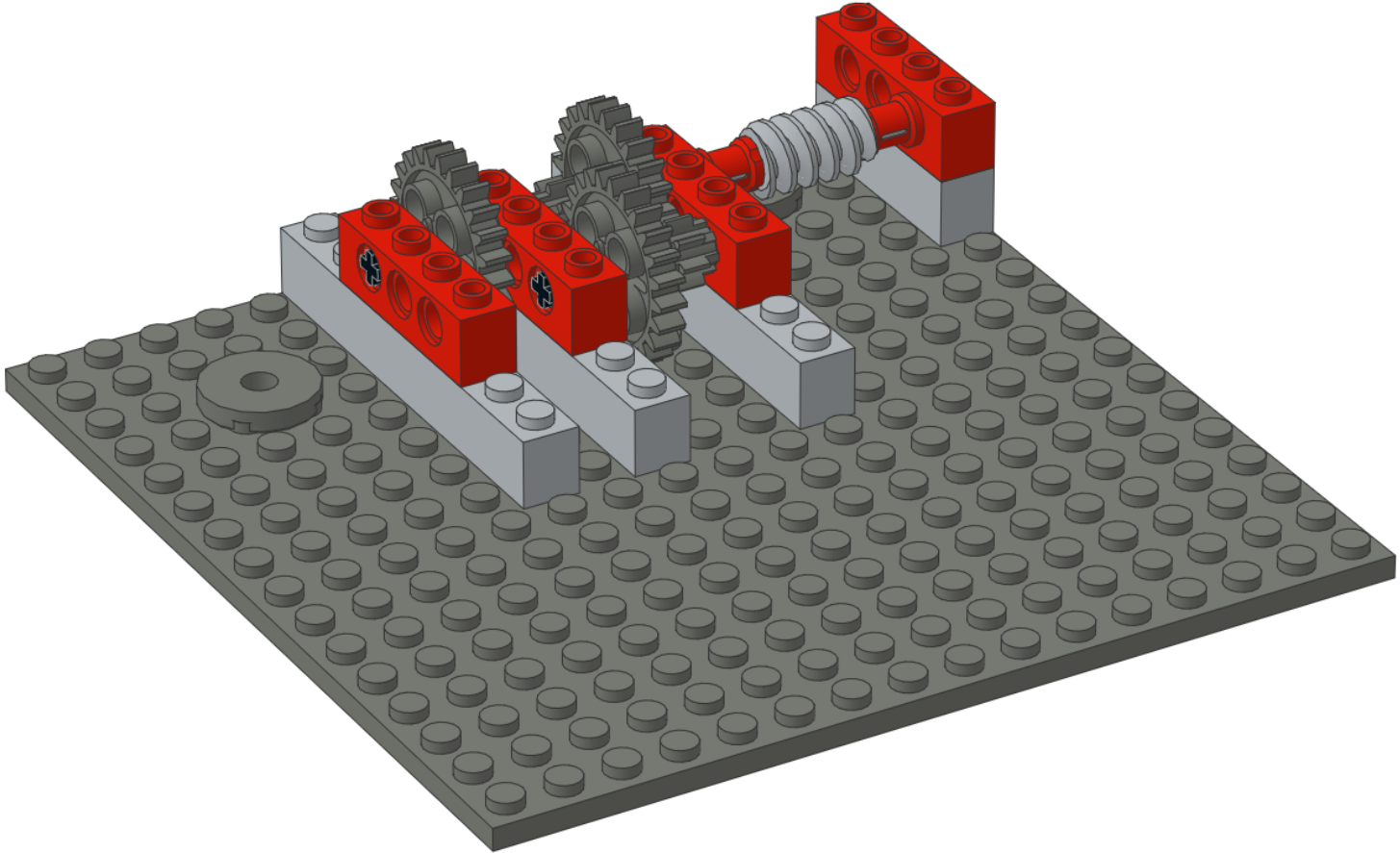

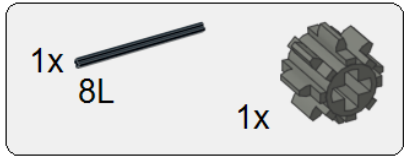

8

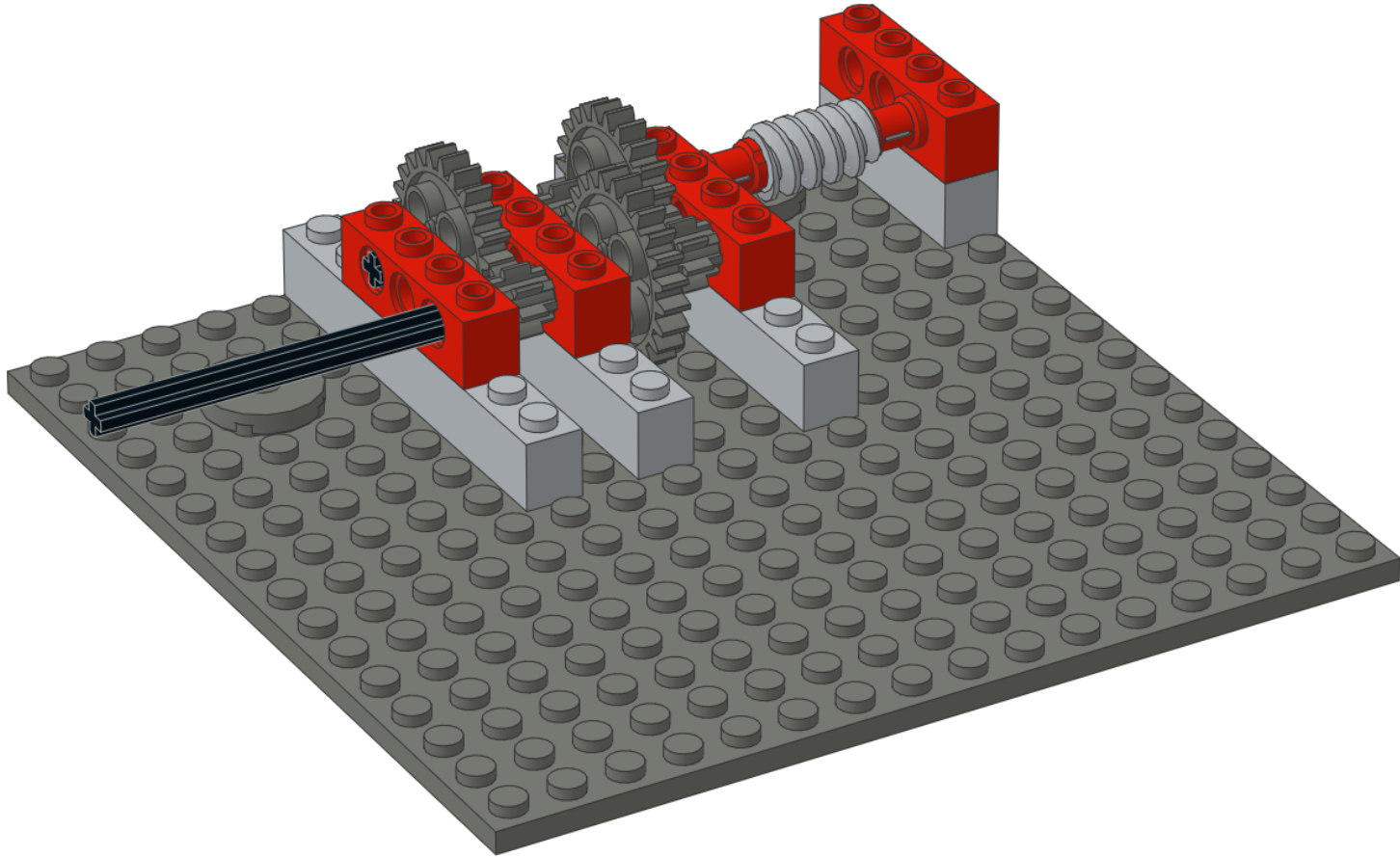

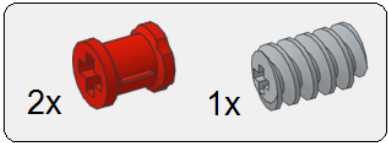

9

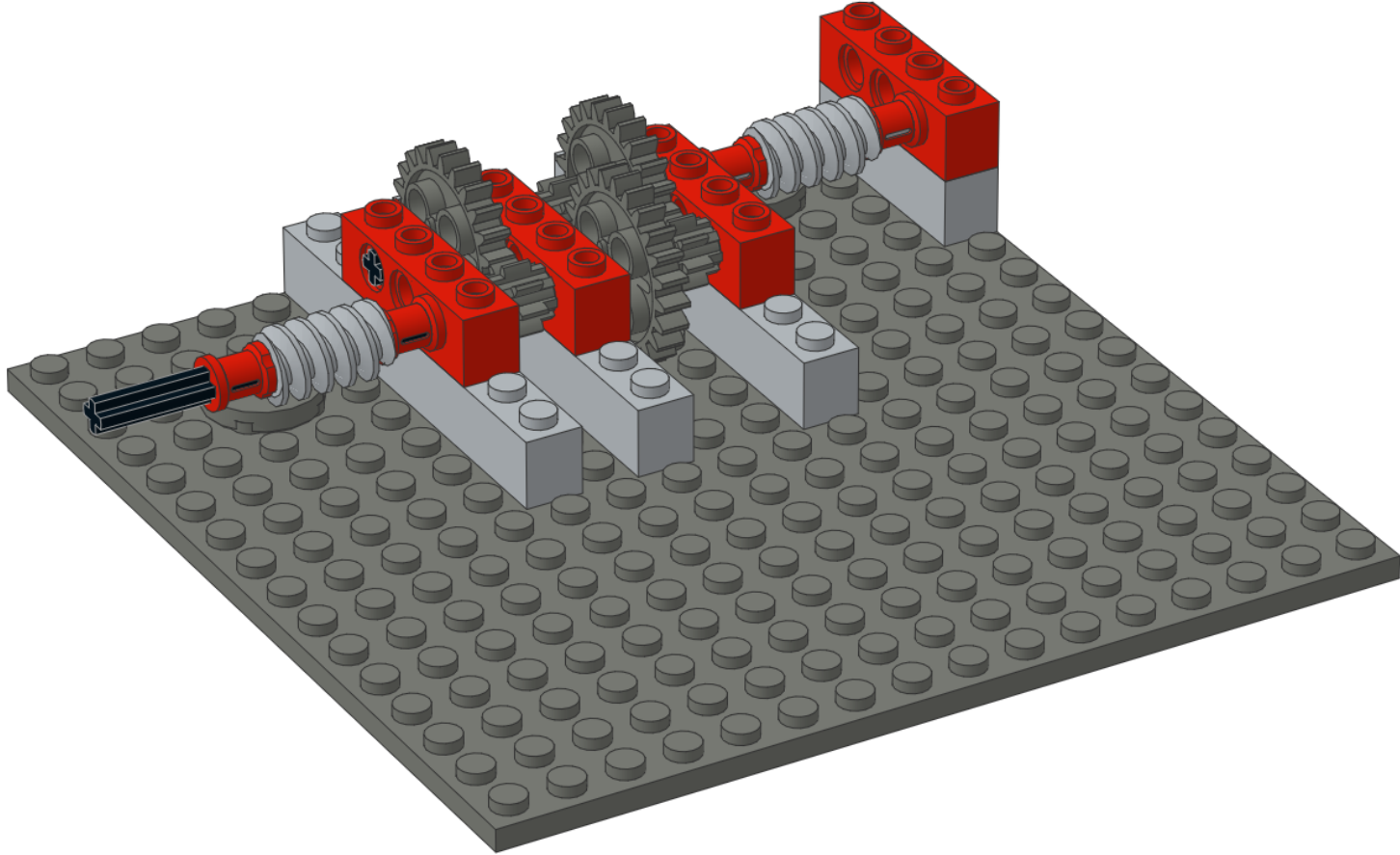

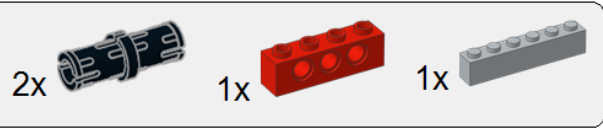

10

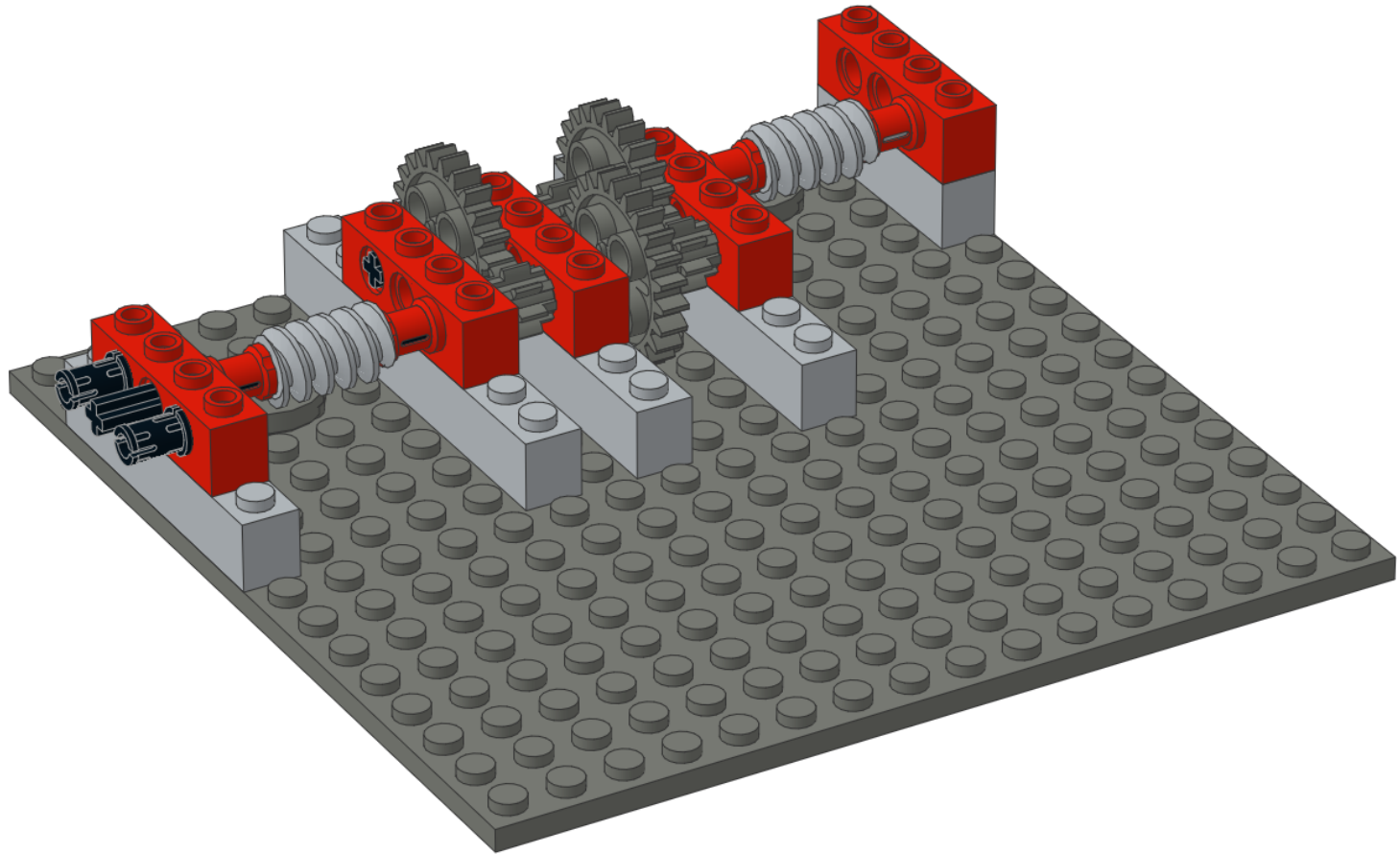

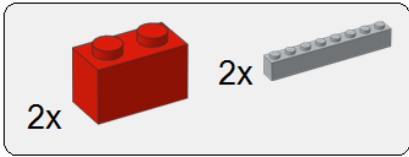

11

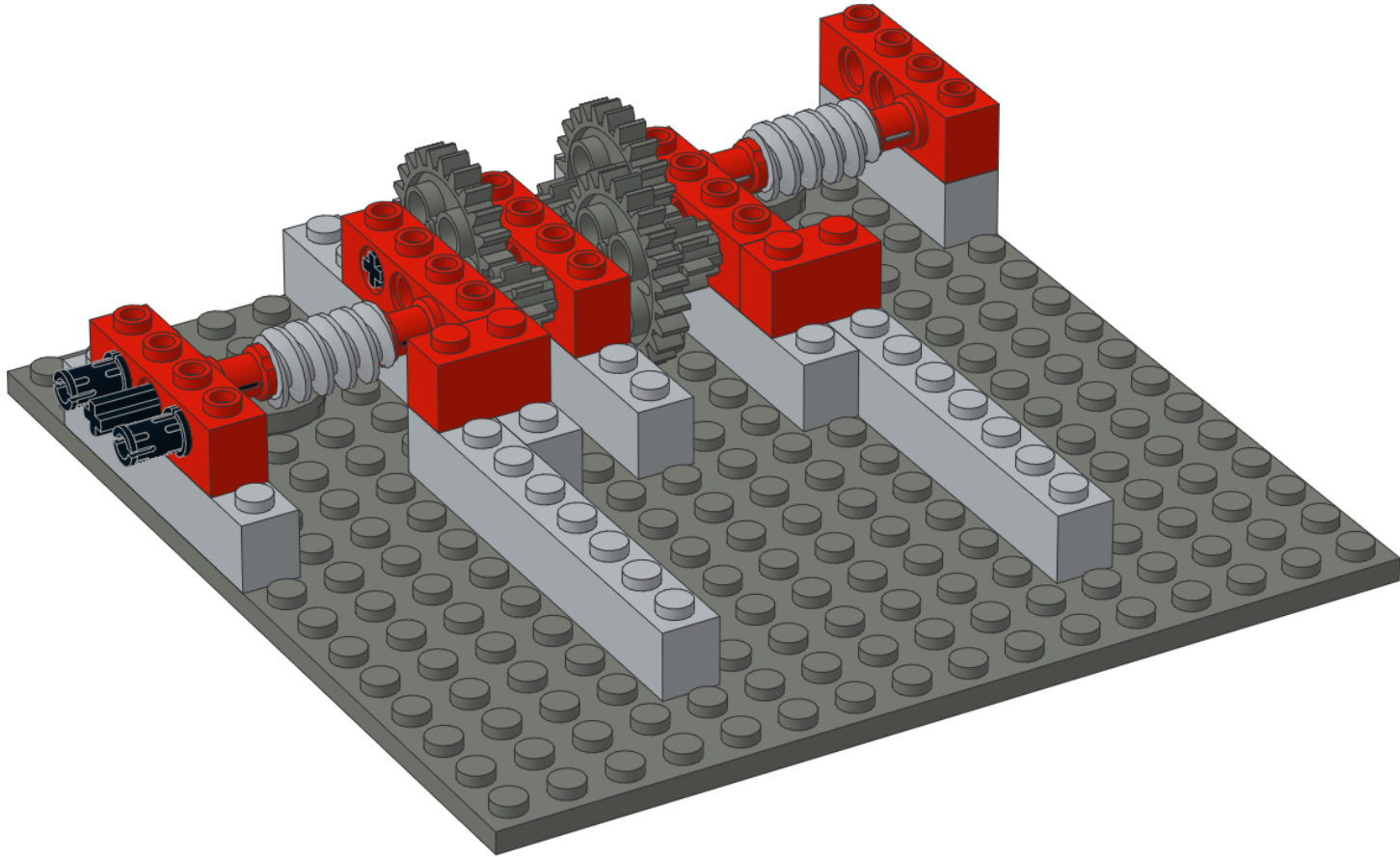



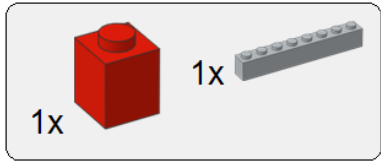

12

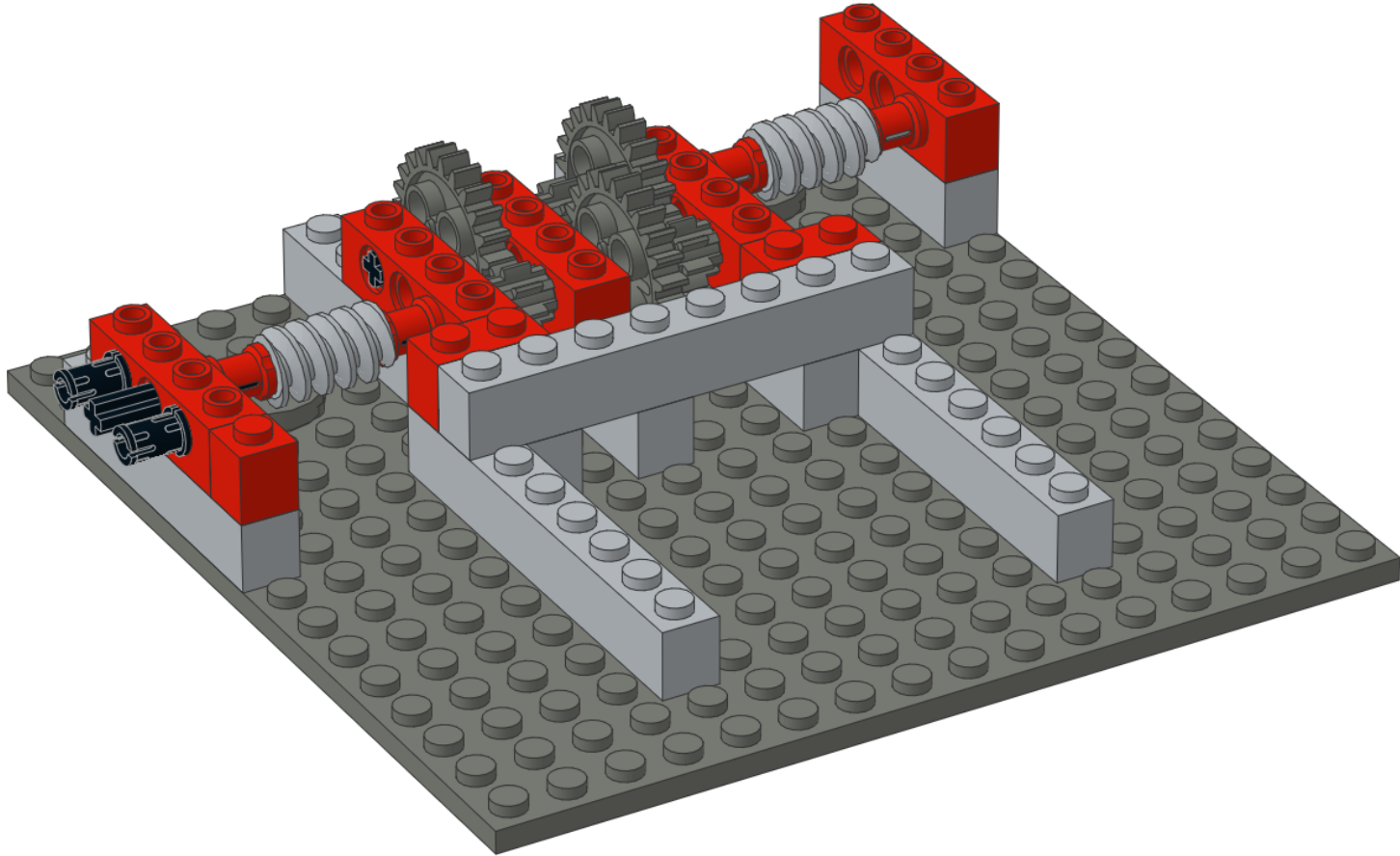

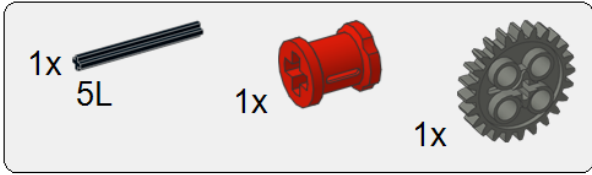

13

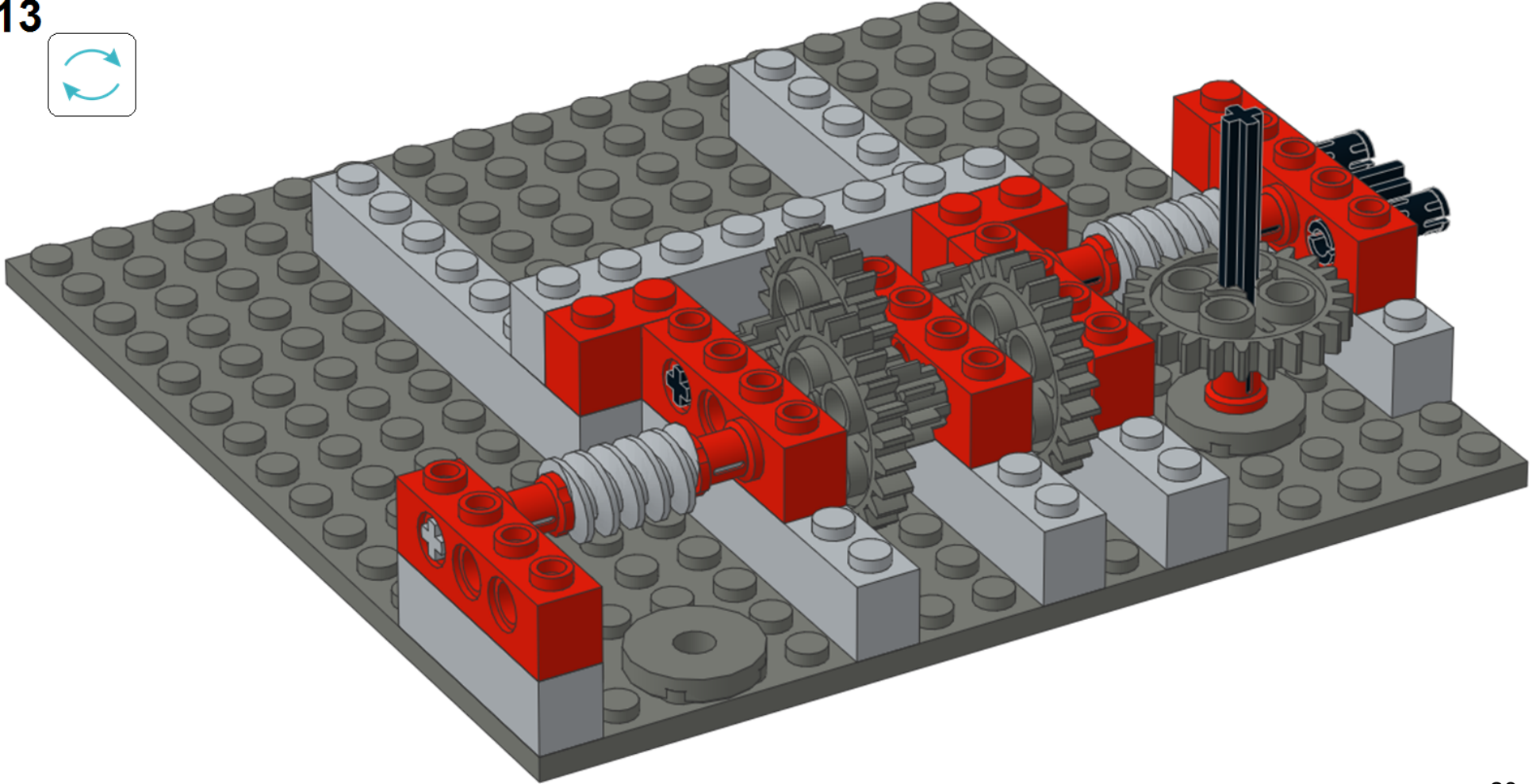

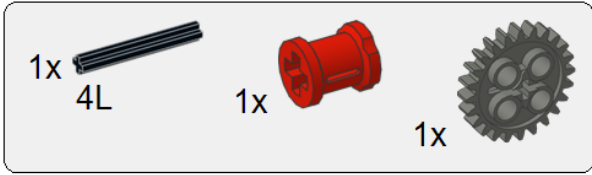

14

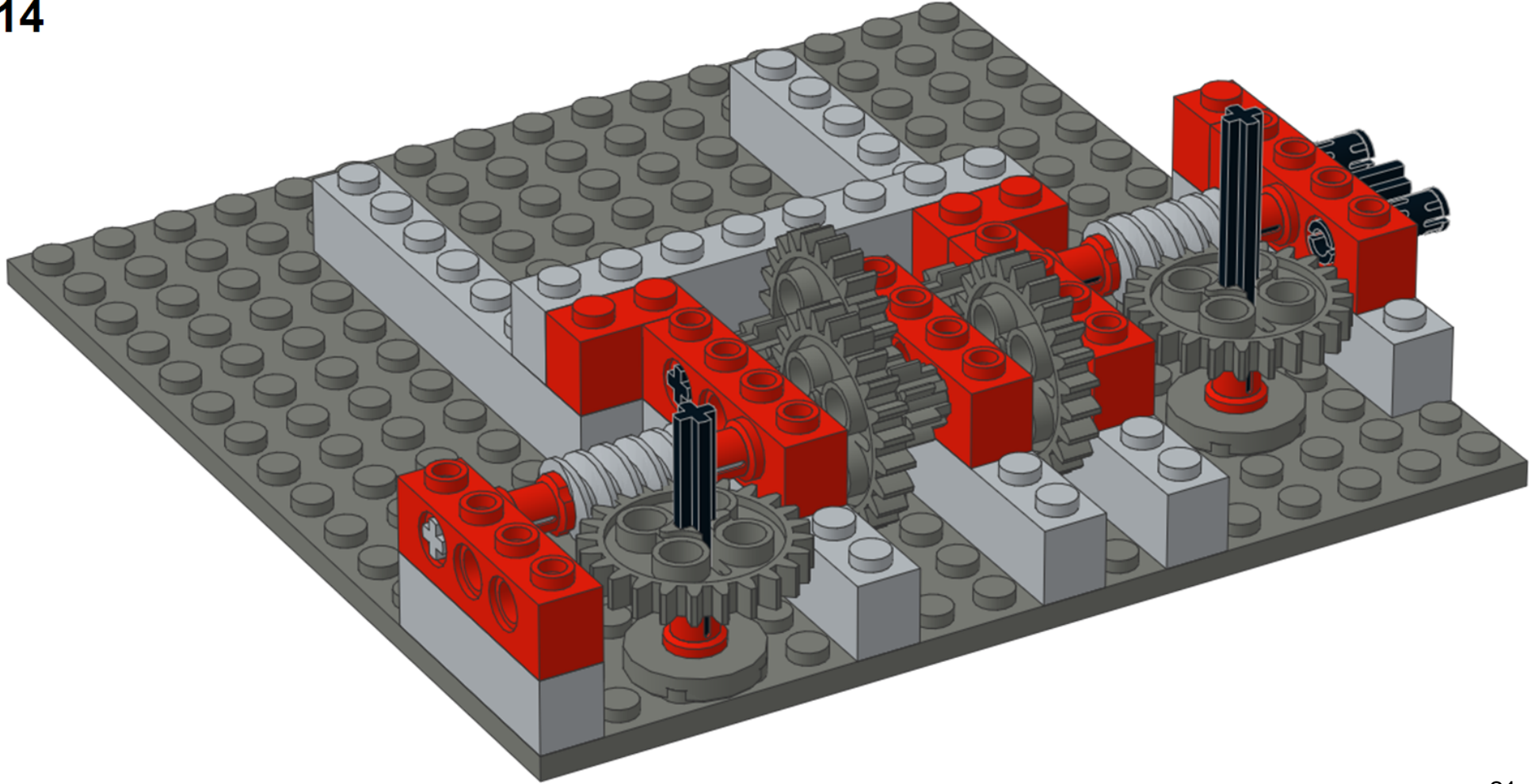

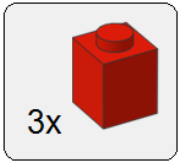

15

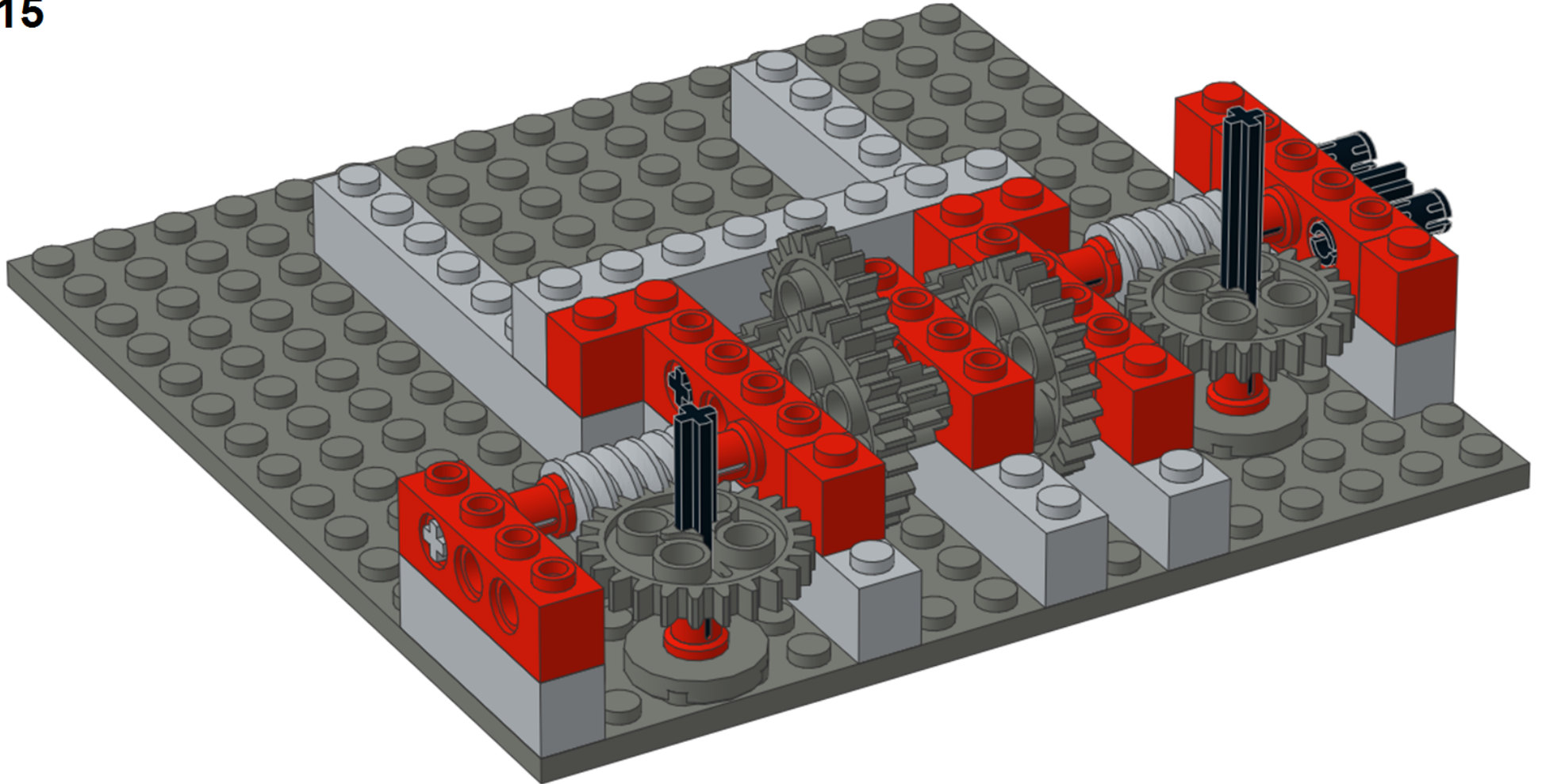



2x



1x

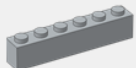

16

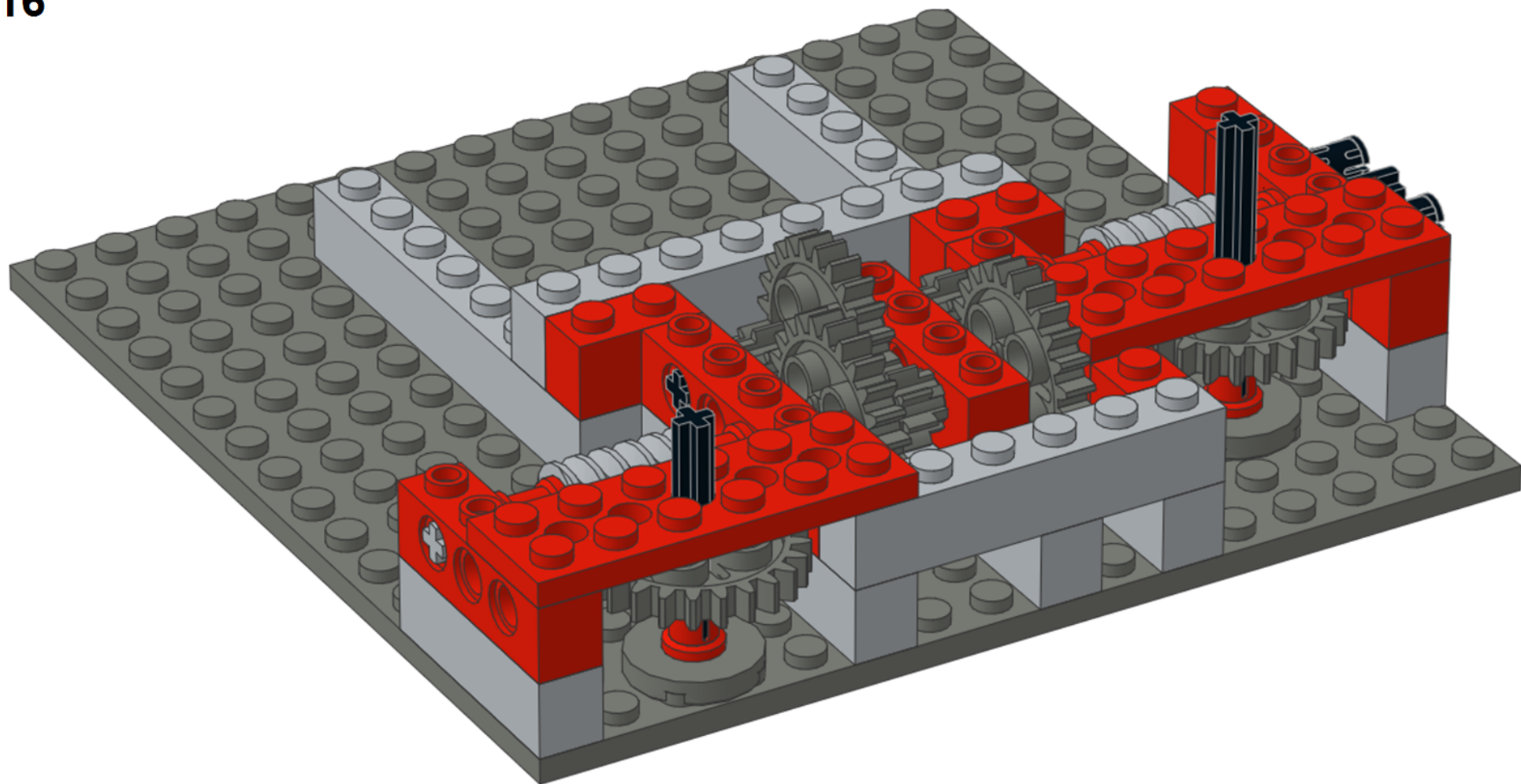

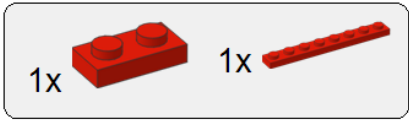

17

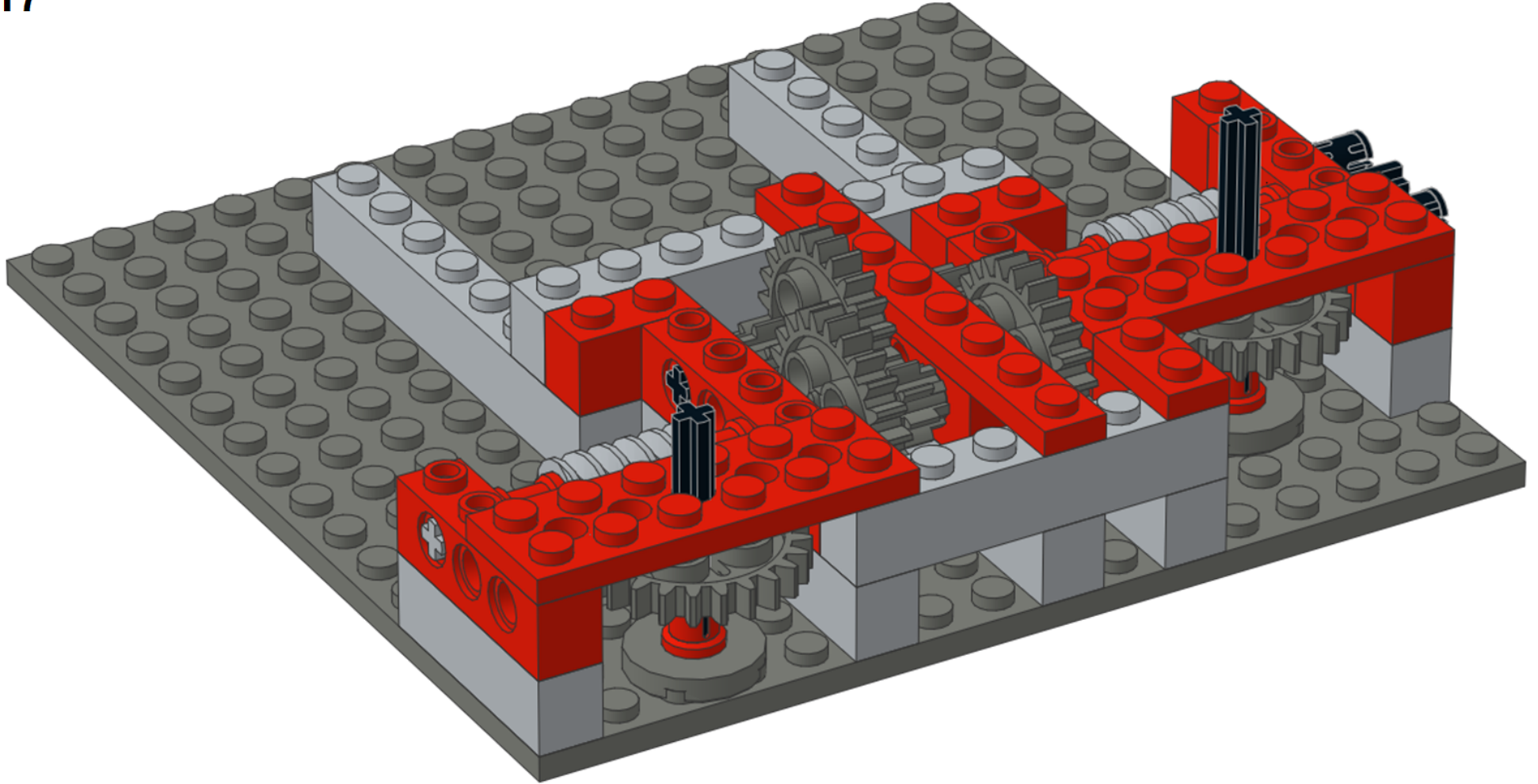

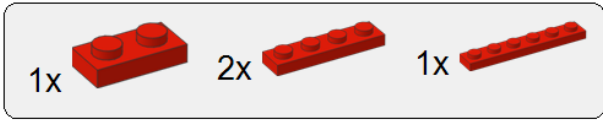

18

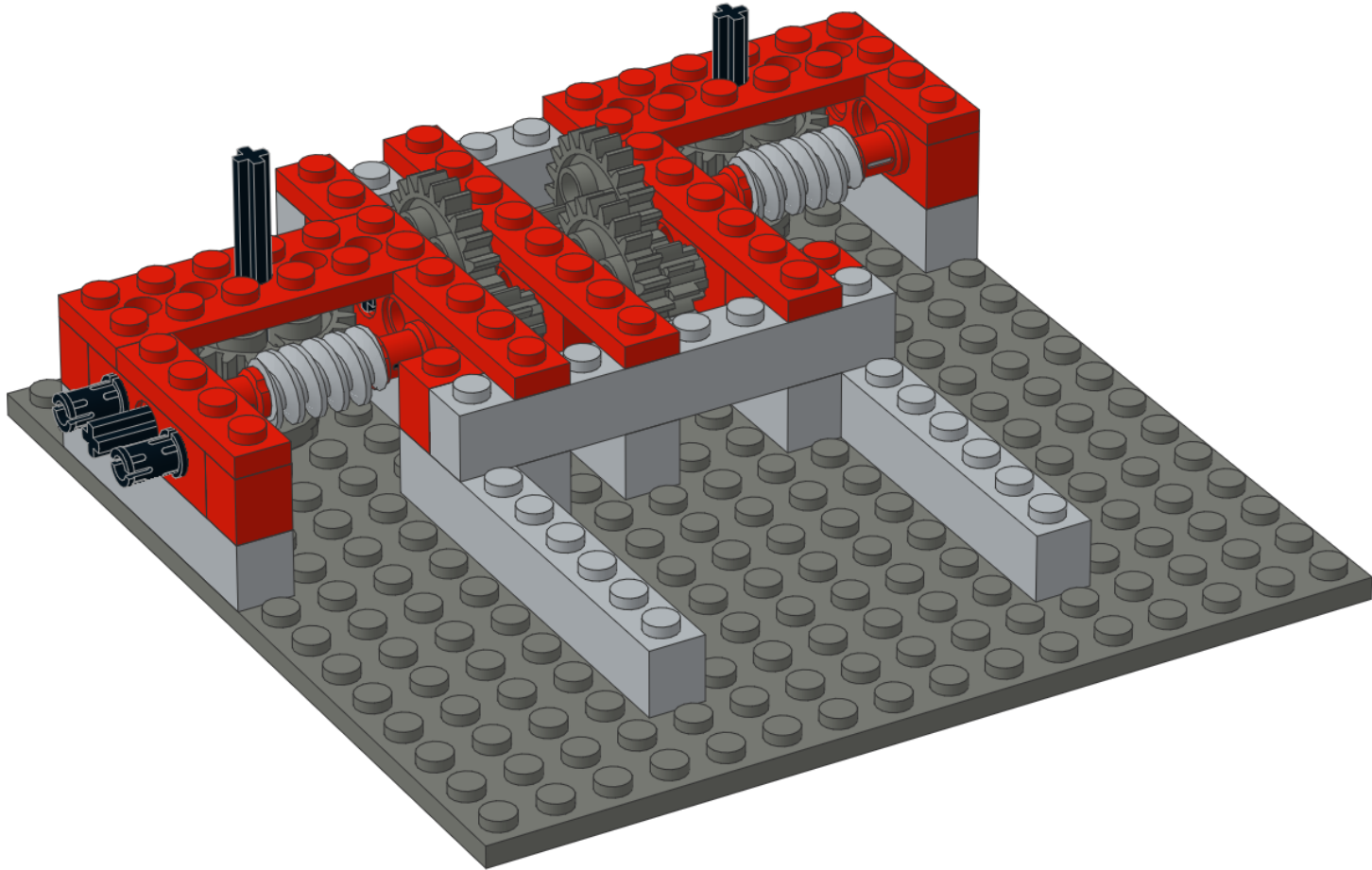



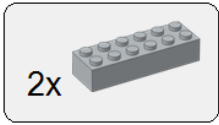

19

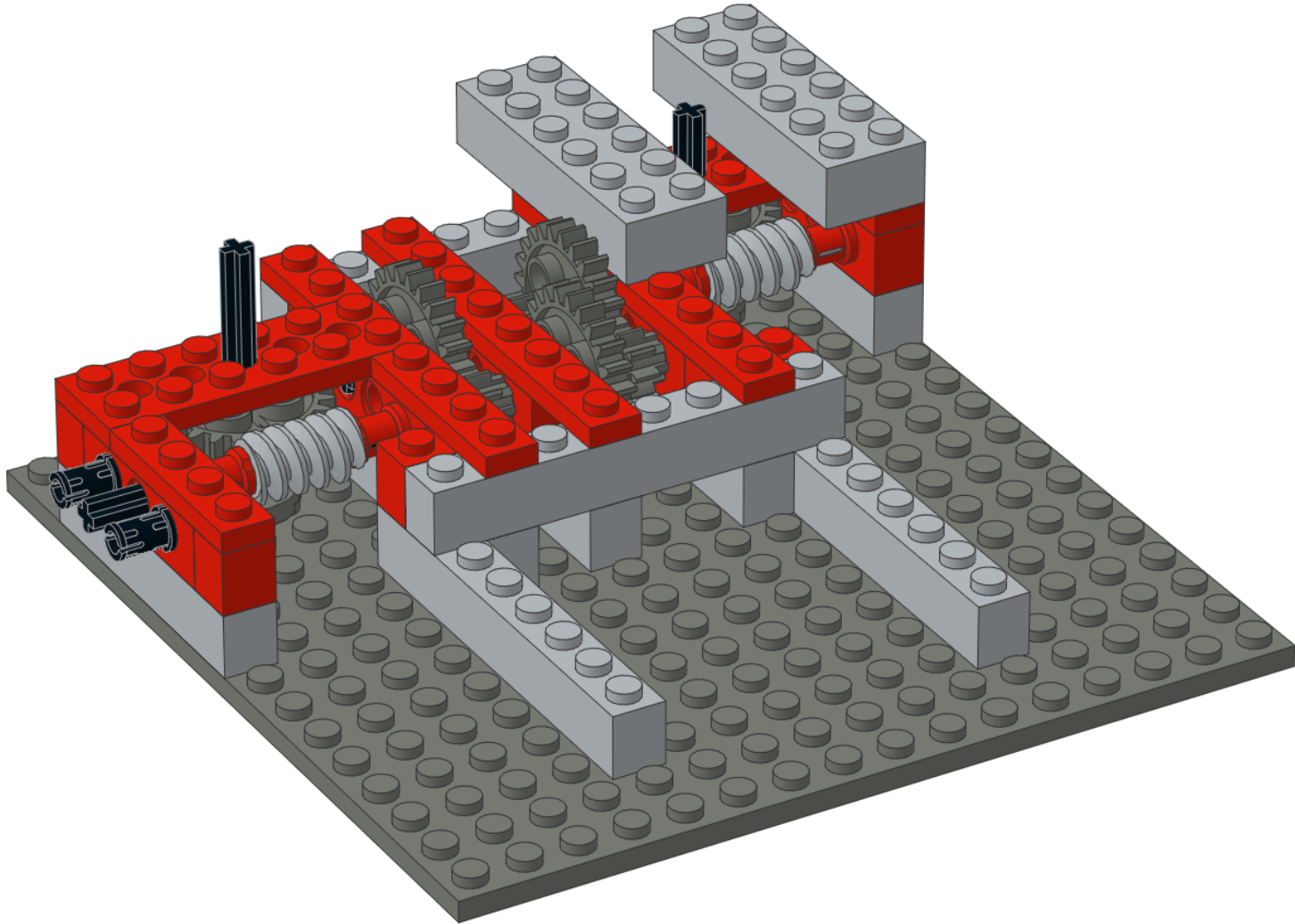









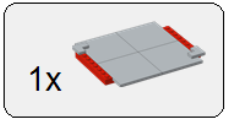

24

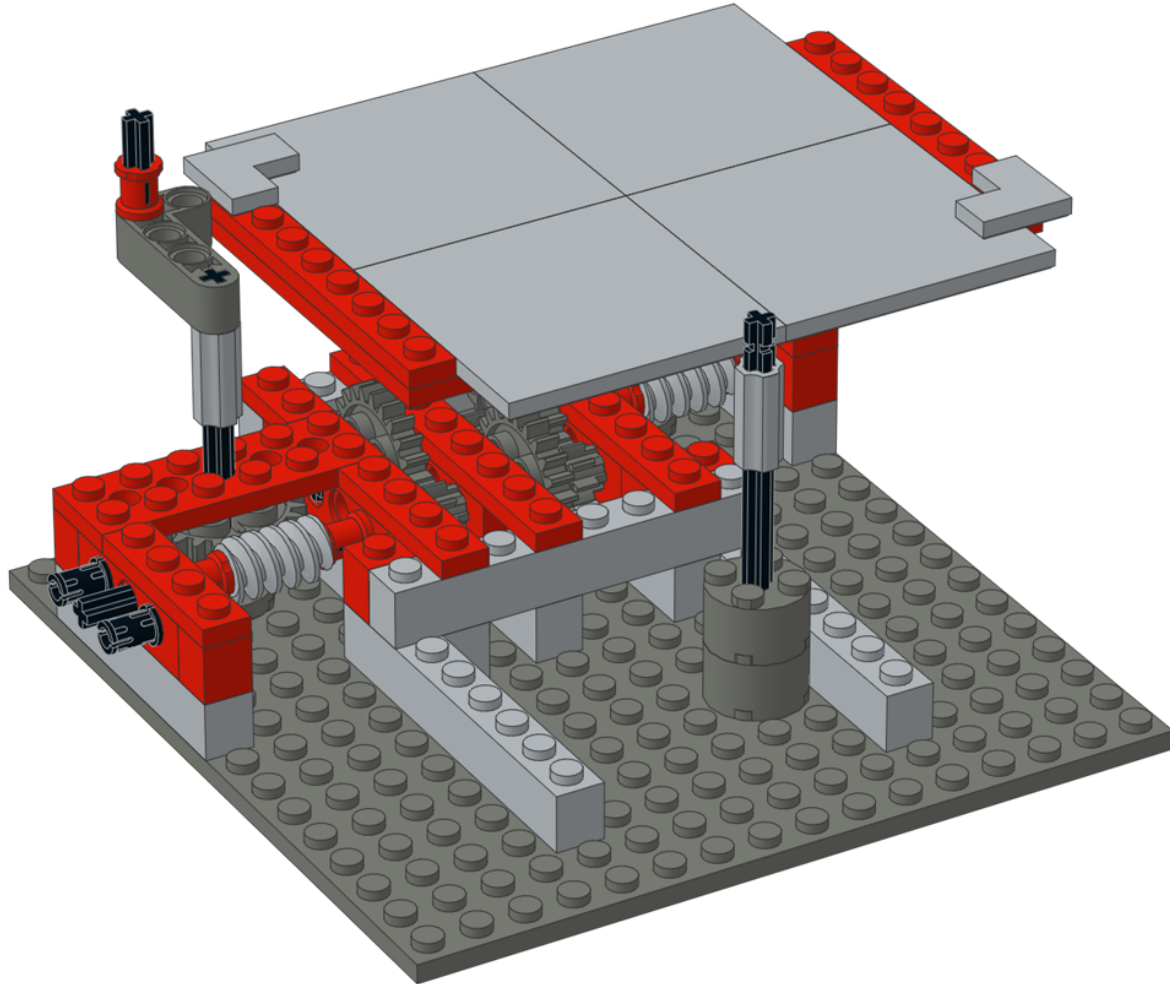



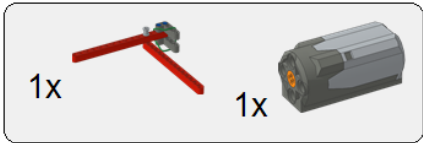

25

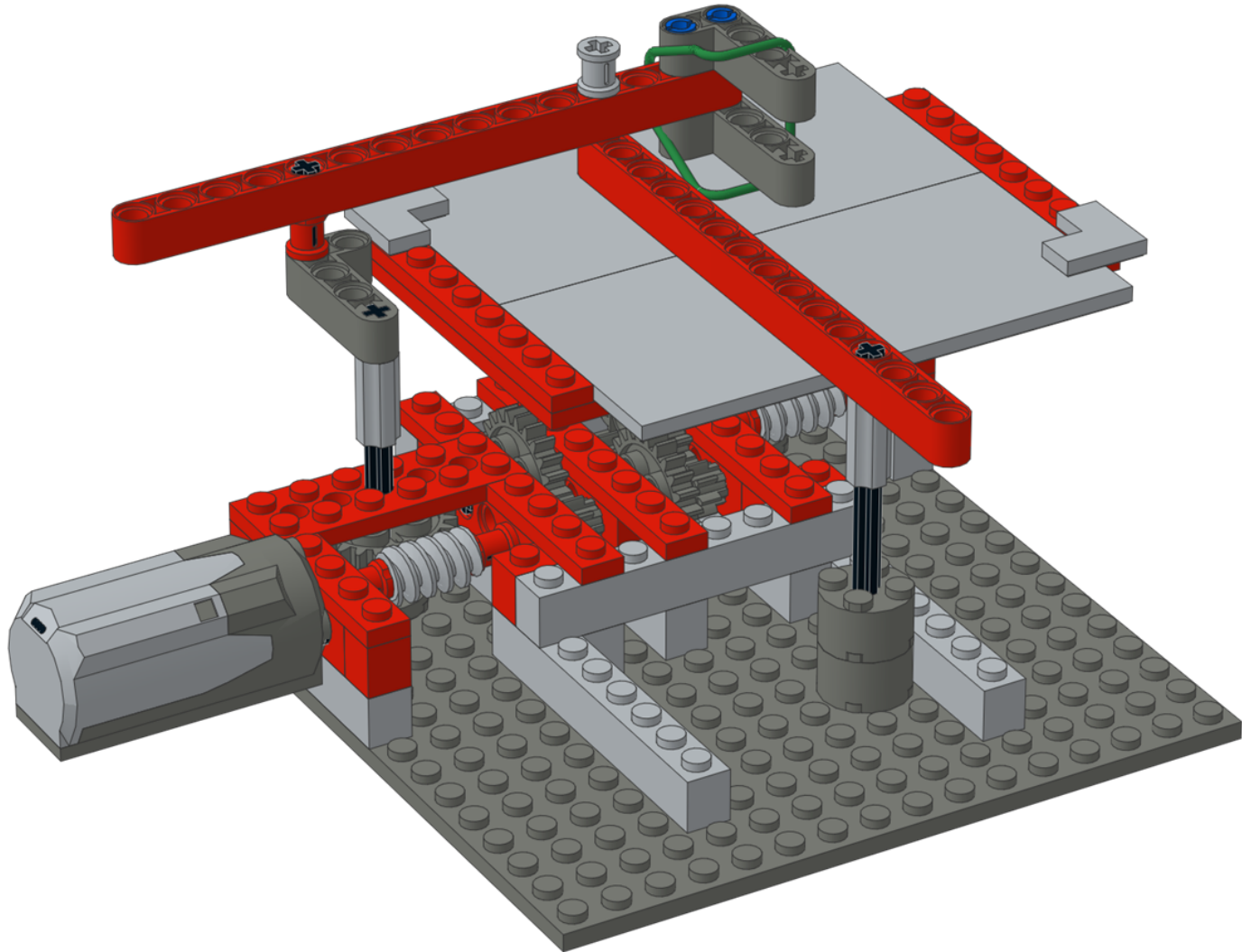



2x   
2L

1x   
3L

3x   
4L

1x   
5L

1x   
6L

1x   
8L

2x 

2x 

1x 

4x 

2x 

1x 

2x 

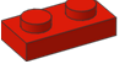
2x 

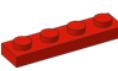
2x 

1x 

3x 

2x 

2x 

5x 

7x 

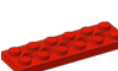
2x 

4x   
4L

2x   
6L

1x 

2x 

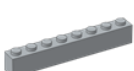
6x 

2x 

1x 

1x 

1x   
7L

2x 

1x 

2x 

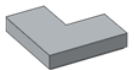
2x 

4x 

2x 

1x 

1x 

3x 

3x 

3x 

5x 

2x 

2x 

## 1610 Drawing Machine

A custom model design by Jason Allemann

Copyright © 2016

To see more of our models, visit [jkbrickworks.com](http://jkbrickworks.com)

These instructions were created using the LDraw system of tools.  
For more information, visit [ldraw.org](http://ldraw.org). Publishing was done using  
Instructor version 1.6

These instructions and the model they depict are in no way  
sponsored, endorsed, or authorized by The LEGO Group.